

Installation Manual

905U-L Wireless I/O

Version 1.8





Document information

Installation Manual 905U-L Wireless I/O Version 1.8

ELPRO contact details

Address > 9 /12 Billabong Street Stafford, QLD 4053
Telephone > + 61 (0)7 3352 8600
Fax > + 61 (0)7 3352 8677
Email > sales@cooperindustries.com
Website > www.cooperbusmann.com/wireless

Copyright

Copyright © ELPRO Technologies Pty Ltd. All rights reserved.

Limited lifetime warranty, disclaimer and limitation of remedies

ELPRO products are warranted to be free from manufacturing defects for the “serviceable lifetime” of the product. The “serviceable lifetime” is limited to the availability of electronic components. If the serviceable life is reached in less than three years following the original purchase from ELPRO, ELPRO will replace the product with an equivalent product if an equivalent product is available.

This warranty does not extend to:

- Failures caused by the operation of the equipment outside the particular product's specification, or
- Use of the module not in accordance with this User Manual, or
- Abuse, misuse, neglect or damage by external causes, or
- Repairs, alterations, or modifications undertaken other than by an authorized Service Agent.

ELPRO's liability under this warranty is limited to the replacement or repair of the product.

This warranty is in lieu of and exclusive of all other warranties. This warranty does not indemnify the purchaser of products for any consequential claim for damages or loss of operations or profits and ELPRO is not liable for any consequential damages or loss of operations or profits resulting from the use of these products. ELPRO is not liable for damages, losses, costs, injury or harm incurred as a consequence of any representations, warranties or conditions made by ELPRO or its representatives or by any other party, except as expressed solely in this document.



Contents

Contents	3
About this document	7
Installing your unit	8
Unit components and connections	9
Transmitter unit	9
Receiver unit	11
Installing the antenna	13
Supported antennas	13
Radio transmission distances	15
Installing and earthing antennas	16
Dipole and collinear antennas	17
Dipole antennas	17
Collinear antennas	17
Yagi antennas	19
Installing the power supply	21
Inputs and outputs	22
Digital inputs	23
Relay outputs	24
Status outputs	25
Analog input	26
Thermocouple input	29
Pulse input	30
Analog output	31
Installing and configuring the unit	33
Installing the unit	34
Configuring your units	35
Testing your units	36
Unit specifications	37
Transmitter unit	37
Receiver unit	37
Ancillary hardware reference information	38
RS232 serial cable	38
Index	39



This page intentionally left blank.



****IMPORTANT ELECTRICAL SAFETY INFORMATION****

In order to comply with Electrical Safety Regulations, this module must be installed in an Electrical AND Fire enclosure. This enclosure may be a single or multiple enclosures. Access to the module is to be made by a Service Person only.

Warning:

Incorrect termination of supply wires may cause internal damage and will void warranty.

To ensure your 905U-L enjoys a long life, double-check **ALL** your connections with the *Installation Guide* before powering on the module.

FCC Notice:

This device complies with Part 15.247 of the FCC Rules. Operation is subject to the following two conditions:

- This device may not cause harmful interference; and
- This device must accept any interference received, including interference that may cause undesired operation

This device must be operated as supplied by ELPRO Technologies. Any changes or modifications made to the device without the written consent of ELPRO Technologies may void the user's authority to operate the device.

End user products that have this device embedded must be installed by experienced radio and antenna personnel, or supplied with non-standard antenna connectors, and antennas available from vendors specified by ELPRO. Please contact ELPRO for end user antenna and connector recommendations.

In accordance with 47 CFR Part 15 Subpart C Section 15.203 only the following antenna/coax cable kits combinations can be used.

Manufacturer	Model Number	Coax Kit	Net
ELPRO	DG900-1	Includes 1m Cellfoil	-2dBi Loss
ELPRO	DG900-5	Includes 5m Cellfoil	-3dBi Loss
ELPRO	CFD890EL	Includes 5m Cellfoil	Unity Gain
ELPRO	SG-900EL	CC10/900	1.8dBi Gain
ELPRO	SG-900EL	CC20/900	-1.2dBi Loss
ELPRO	SG-900-6	CC10/900	4.8dBi Gain
ELPRO	SG-900-6	CC20/900	1.8dBi Gain
ELPRO	YU6/900	CC20/900	3.8dBi Gain

Part	Additional information
15	This device has been tested and found to comply with the limits for a Class B digital device, pursuant to Part15 of the FCC rules (Code of Federal Regulations 47CFR Part 15). Operation is subject to the condition that this device does not cause harmful interference.
90	This device has been type accepted for operation by the FCC in accordance with Part90 of the FCC rules (47CFR Part 90). See the label on the unit for the specific FCC ID and any other certification designations.

**Safety Notice:**

Exposure to RF energy is an important safety consideration. The FCC has adopted a safety standard for human exposure to radio frequency electromagnetic energy emitted by FCC regulated equipment as a result of its actions in Docket 93-62 and OET Bulletin 65 Edition 97-01.

Industry Canada: 905U Wireless I/O Module

RSS-119 - This device has been type accepted for operation by Industry Canada in accordance with RSS-119 of the Industry Canada rules. See the label on the unit for the specific Industry Canada certification number and any other certification designations.

Any changes or modifications not expressly approved by ELPRO Technologies P/L could void the user's authority to operate this equipment.

To operate this equipment legally the user must obtain a radio-operating license from the government agency. This is done so the government can coordinate radio users in order to minimize interference.

UL Notice:

THIS EQUIPMENT IS SUITABLE FOR USE IN CLASS I DIVISION 2 GROUPS A,B,C AND D HAZARDOUS LOCATIONS, OR NONHAZARDOUS LOCATIONS ONLY.

WARNING - EXPLOSION HAZARD - DO NOT DISCONNECT EQUIPMENT WHILE THE CIRCUIT IS LIVE OR UNLESS THE AREA IS KNOWN TO BE FREE OF IGNITABLE CONCENTRATIONS.

WARNING - EXPLOSION HAZARD - SUBSTITUTION OF ANY COMPONENT MAY IMPAIR SUITABILITY FOR CLASS I, DIVISION 2.

1. The Wireless I/O module is to be installed by trained personnel / licensed electricians only and installation must be carried out in accordance with the instructions listed in the Installation Guide and applicable local regulatory codes.
2. The units are intended for Restricted Access Locations.
3. The Wireless I/O module is intended to be installed in a final enclosure, rated IP54, before use outdoors.
4. The Equipment shall be powered using an external Listed Power Supply with LPS outputs or a Class 2 Power Supply.
5. The Wireless I/O module must be properly grounded for surge protection before use.



About this document

This document is the **905U-L Wireless I/O Installation Manual** that describes how to install your 905U-L units and contains important information for installing your units with other equipment.

Note

If your network only contains one transmitter and receiver pair, you should also read the 905U-L QuickStart Guides.

This document contains the following sections:

Section	Read this section if you want to ...
Basic steps for using your unit	Learn the basic steps for installing and using your unit.
Factory default configuration	Understand how the transmitter sends information to the receiver.
Unit components	Understand the different parts of your unit.
Antenna installation	Learn how to install an antenna with your unit.
Resetting factory defaults	Reset your unit to the original factory default settings.
Linking transmitter and receiver units	Link your units to work as a dedicated pair.
Safety information	Understand important safety information related to your unit. NOTE: You must read this information before installing your unit.
Specifications	Know technical information about your unit.

For more information, see the next sections.



Installing your unit

This section describes how to install your unit and contains the following sections:

Step	Description	For more information, see ...
1 – Read the safety information	Lets you understand important safety information related to your unit. NOTE: You must read this information before installing your unit.	Warning: on page 5.
2 – Get to know the unit features	Understand the basic features of your unit.	Unit components and connections on page 9.
3 – Install the antenna	Learn how to install an antenna with your unit.	Installing the antenna on page 13.
4 – Install the power supply	Learn how to install a power supply for your unit.	Installing the power supply on page 21.
5 – Install the units	Learn how to install your unit.	Installing the unit on page 34.
6 – Linking and configuring the unit	Learn how to link and configure your units to transmit and receive information.	Configuring your units on page 35.
7 – Test the unit	Understand the principles for testing your units.	Testing your units on page 36.

Note

To ensure internal surge protection works correctly, you must earth each unit using the Earth terminal.

For more information, see the next sections.



Unit components and connections

This section shows the components and terminal connections for the transmitter and receiver units.

Transmitter unit

The 905U-L-T transmitter unit has the following components and terminal connections:

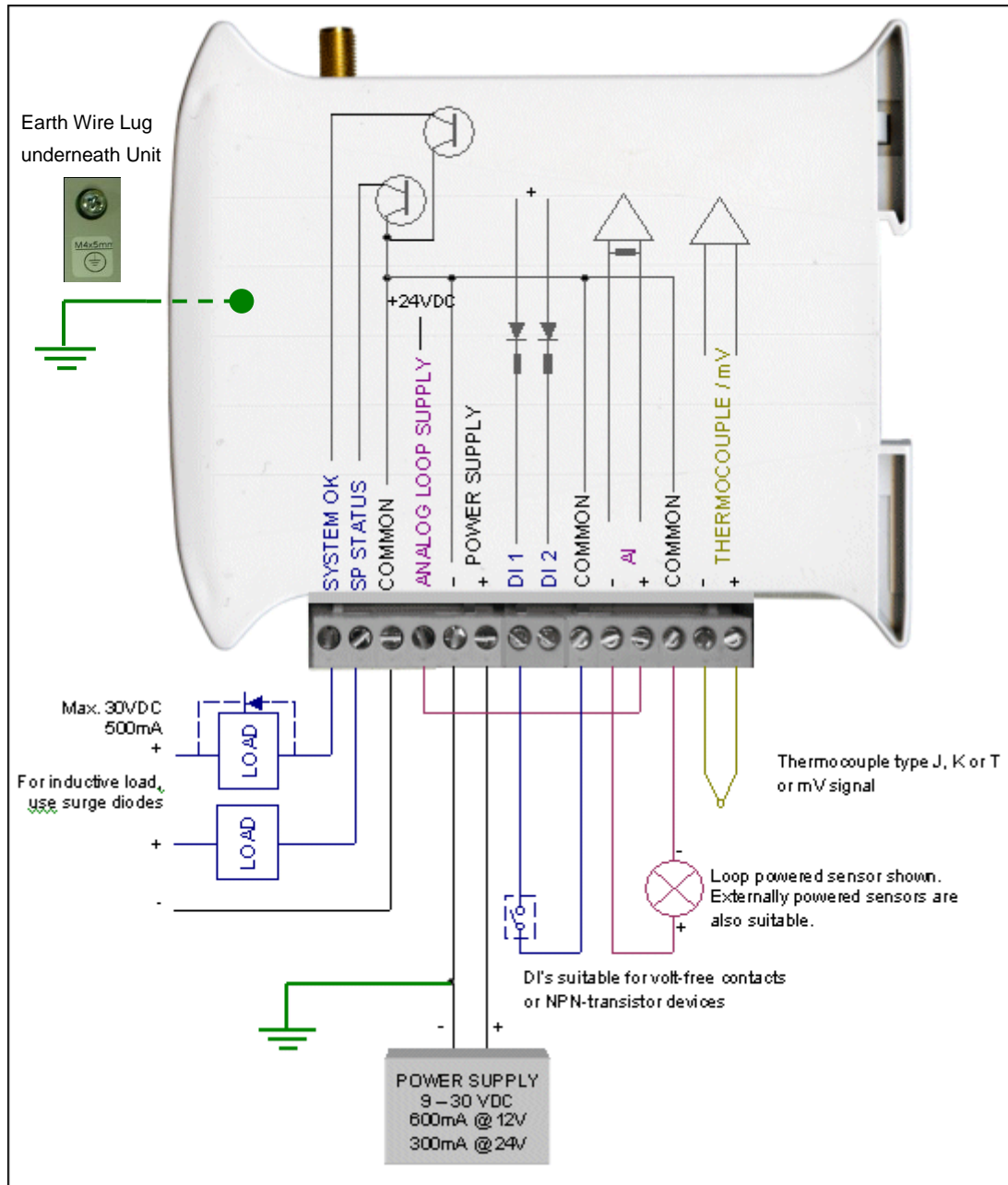



The front panel contains the following components:

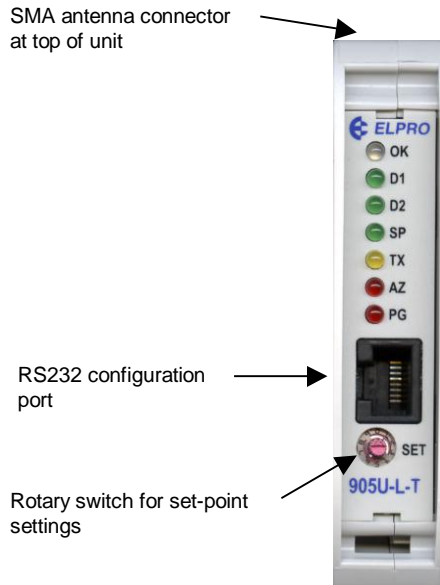

The triangle on the rotary switch indicates the current position, for example:

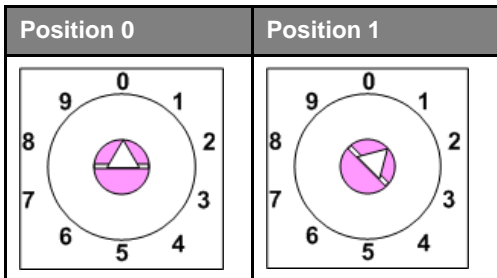

NOTE: To avoid damaging the rotary switch, use a screwdriver to change the position.

The rotary switch controls the setpoint levels on the Analog and Thermocouple inputs.

The LEDs on the front panel indicate the unit status:

LED Status	Indicates	
None	No power supply.	
OK LED Green	Current status of the unit OK.	
OK LED Red	Fault condition detected in unit.	
TX Led Flashes	Transmitting Message.	
PG LED on	Configuration Cable Connected.	
Input LED ON	Input LEDs (i.e. D1, D2, SP, AZ.) light when the corresponding input is active.	
	D1	Digital Input 1 is active (Low).
	D2	Digital Input 2 is active.
	SP	Analog Setpoint is active.
	AZ	Analog Input is zero mA
All LEDs medium flash	Medium speed flash (1.6HZ) indicates the module is halfway through the configuration process. Medium flash also happens when you set the rotary switch to position 0 when powering on the unit.	



Receiver unit

Your 905U-L-R unit has the following components and terminal connections:

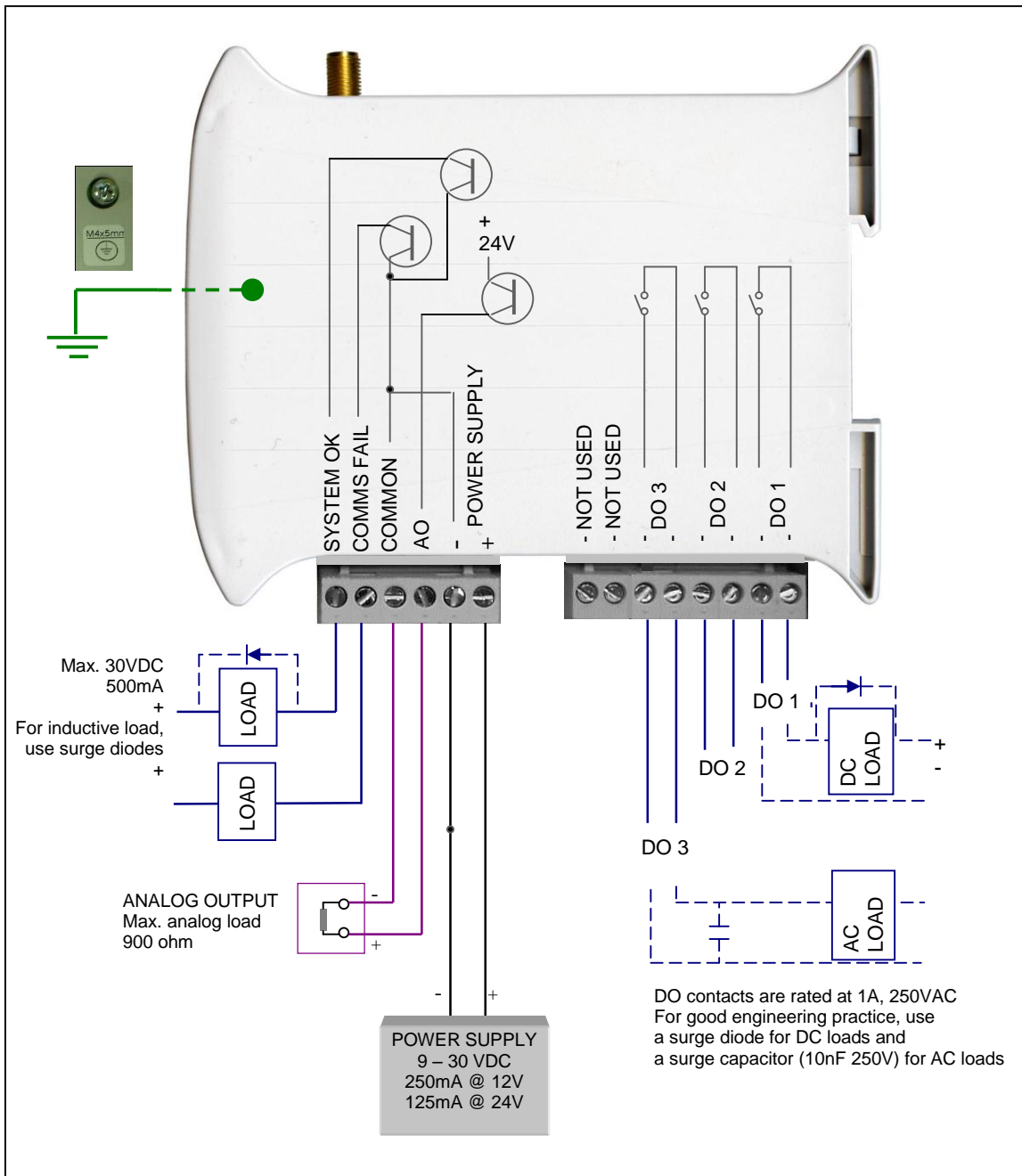



The front panel contains the following components:

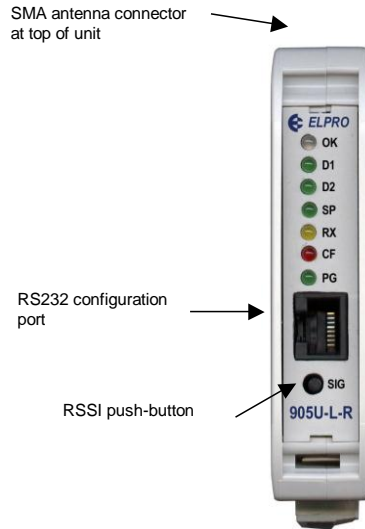

The LEDs on the front panel indicate the unit status:

LED Status	Indicates			
None	No power supply.			
OK LED Green	Current status of the unit OK.			
OK LED Red	Fault condition detected in unit.			
RX Led Flashes	Receiving Message.			
CF Led ON	Module Communication Failure Output is active.			
PG LED on	Configuration Cable Connected.			
Output LED ON	The Output LEDS (i.e. D1, D2, D3) light when the corresponding output is active.			
	D1	Relay output D1 is ON (Contact Closed).		
	D2	Relay Output D2 is ON.		
	D3	Relay Output D3 is ON.		
LEDs with RSSI Push Button Pressed	When you press the RSSI push button, the unit shows the signal strength by lighting the LEDs from the bottom to the top. Signal strength is the strength of the last message received that was addressed to this station.			
	LED	Signal Strength	LED	Signal Strength
	D1	More than -85 dBm	RX	More than -100 dBm
	D2	More than -90 dBm	CF	More than -105 dBm
	D3	More than -95 dBm	PG	Always on during RSSI test
Output LED flashing quickly	If an output is in communication failure, the corresponding LED flashes at 5 Hz.			
	D1	Relay Output D1 is in communication failure.		
	D2	Relay Output D2 is in communication failure.		
	D3	Relay Output D3 is in communication failure.		
	PG	Analog output is in communications failure.		



Installing the antenna

This section explains how to install your antenna and contains the following sections:

Section	Description	For more information, see ...
Supported antennas and cables	Details the antennas and cables you can use with the units.	Supported antennas on page 13.
Radio transmission distances	Details the distances for reliable operation.	Radio transmission distances on page 15.
Installing and earthing antennas	Details important information about installing and earthing antennas.	Installing and earthing antennas on page 16
Dipole and collinear antennas	Details important information about using dipole and collinear antennas.	Dipole and collinear antennas on page 17.
Yagi antennas	Details important information about using Yagi antennas.	Yagi antennas on page 19.

For more information, see the next sections.

Supported antennas

You can use the following antennas with the units:

Antenna	Additional information	Total gain (including cable)
WH900	Whip antenna for mounting directly onto the module - operation up to ½ mile (1 km).	-6 dBi
CFD890EL	0 dBi Dipole antenna with 15' of Cellfoil cable and SMA connector.	0 dBi
SG900EL	5dBi Collinear omni-directional antenna with N-type connector.	5 dBi
SG900-6	8dBi Collinear omni-directional antenna with N-type connector.	8 dBi
YU6/900	10dBi Yagi directional antenna with N-type connector.	10 dBi
YU16/900	15dBi Yagi directional antenna with N-type connector.	15 dBi

You can use the following cables with the units:

The following table shows compatible cables for different antennas when used with the 905U-L-T:

Antenna	North America	Australia/NZ
SG900EL	Any cable.	CC10 or CC20.
SG900-6	Any cable.	CC20.
YU6/900	CC20.	External cable with loss > 9dB.
YU16/900	External cable with loss > 9dB.	External cable with loss > 15 dB



You must carefully select antennas for 905U-L-T modules to avoid contravening the maximum power limit on the unlicensed channel. The net gain of the antenna/cable configuration should be no more than 6dB in North America (USA, Canada, Mexico) and no more than 0 dB in Australia / New Zealand.

Note

The net gain of an antenna/cable configuration is the gain of the antenna (in dBi) less the loss in the coaxial cable (in dB).

For example, an SG900-6 antenna with a CC20/900 cable has a net gain of 2dB (i.e. +8 dB – 6 dB) at 900 MHz.

The 905U-L-R module has no limitation on antenna gain, as this module does not incorporate a radio transmitter.

The following table details the gains of some typical antennas:

Antenna	Gain (dBi)
Dipole with integral 3m cable	0
Dipole without cable	2
5dBi Collinear (3dBd)	5
8dBi Collinear (6dBd)	8
3 element Yagi	5
6 element Yagi	10

The following table details losses for typical cables:

Cable	Loss (dB per 10m) at 900 MHz
RG58	-5
RG213	-2.5
Cellfoil	-3



Radio transmission distances

The unit will operate reliably over large distances depending on the:

- **Antenna type;**
- **Antenna location;**
- **Amount of radio interference;** and
- **Radio path obstructions** (e.g. hills or trees).

Typical reliable distances are:

Area	Distance	Additional information
USA/Canada	20+ miles	6dB net gain antenna configuration permitted (4W Equivalent RF power permitted).
Australia/NZ	20+ km	Unity gain antenna configuration (1W Equivalent RF power permitted).

To achieve these distance, you must elevate at least one site on a hill or transmission tower.

Modules will operate reliably with some radio path obstruction; however obstructions also reduce the reliable distance.

Note

You must test all obstructed paths to check the reliability of the path.

You can achieve maximum transmission distances if the radio path has “line of sight”. For example, raising antennas above intermediate obstructions including hills, trees, etc. Obstructions reduce the range; however they may not prevent a reliable path.

The closer the obstruction is to the antenna, the greater the blocking effect. For example, a group of trees around the antenna is a larger obstruction than a group of trees further away from the antenna. You can achieve longer distances by mounting one antenna on top of a hill.

Note

Due to the earth’s curvature, you must elevate antennas higher than the ground level between the antennas for longer paths (greater than 3 miles / 5 km).

The unit can tolerate larger amounts of obstructions for shorter distances. For very short distances, you can also mount the antennas inside buildings.

If two 905U modules cannot communicate reliably, you can use a third 905U module as a “repeater” to receive and re-transmit messages. This module may also have input/output (I/O) signals connected to it and form part of the I/O network.

Note

1. ELPRO recommends using the 905U-G module as a repeater unit between 905U-L-T and 905U-L-R modules.

2. To use a repeater unit, the 905U-L modules and the repeater module must be configured using the supplied configuration software. The factory default configuration described in the Quick Start Guide cannot use a repeater unit.



Installing and earthing antennas

You must connect an antenna to each 905 module using the SMA connector at the top of the enclosure.

ELPRO recommends carefully taping the connections between the antenna and coaxial cable to prevent moisture ingress. Moisture ingress in the coaxial cable is a common cause of radio system problem as it greatly increases the radio losses.

ELPRO recommends taping the connection with three layers of tape:

Layer	Tape
1	PVC tape.
2	Vulcanising tape (e.g. 3M 23 tape).
3	Additional layer of PVC UV-stabilized insulating tape.

The first tape layer lets you easily inspect the joint if required as you can easily remove the vulcanising seal.

Note

You must effectively earth all masts for mast-mounted antennas to avoid lightning surges. We also recommend using a coaxial surge diverter for antennas mounted outside industrial plant environments.

If the antenna is not already shielded from lightning strike by an adjacent earthed structure, you can provide shielding by installing a lightning rod above the antenna.

You should connect the antenna to the module using 50 ohm coaxial cable (e.g. RG58 or RG213) terminated with a male coaxial connector. The higher the antenna is mounted, the greater the transmission range; however as the length of coaxial cable increases so do cable losses. For use on unlicensed frequency channels, there are several types of antenna suitable for use.

If you mount antennas on elevated masts, you should effectively earth the masts to avoid lightning surges. The 905U-L radios are fitted with surge protection.

Note

For high lightning risk areas, ELPRO recommends additional surge suppression devices. If the antenna is not already shielded from lightning strike by an adjacent earthed structure, you can install a lightning rod to provide shielding.



Dipole and collinear antennas

This section contains important information for using dipole and collinear antennas. For more information, see the next sections.

Dipole antennas

Unity gain dipole antennas are commonly used on unlicensed channels. The dipole antenna does not provide any gain, so the power transmitted from the antenna is the same as the power out of the module.

A dipole antenna that comes supplied with integral 15 ft cable does not require additional coaxial cable.

You should mount dipole antennas vertically, preferably no less than 1 metre away from a wall or mast for maximum performance.

Collinear antennas

Collinear antennas transmit the same amount of radio power in all directions horizontally, and are easy to install and use. They provide gain by compressing the radiated signal to a flattened disc shape, and reducing the amount of signal radiated above and below the horizontal plane.

Collinear antennas are generally used at a central site with more than one remote site, or at a repeater site.

Collinear antennas are similar in appearance to dipole antennas; however the antenna is longer.

Collinear antennas are supplied without cable, and require additional coaxial cable.

You can use collinear antennas to:

- **Transmitter** – to compensate for the losses in long lengths of coaxial cable.
- **Receiver** – to increase receive sensitivity.



The following diagrams shows the recommended installation for collinear and dipole antennas:

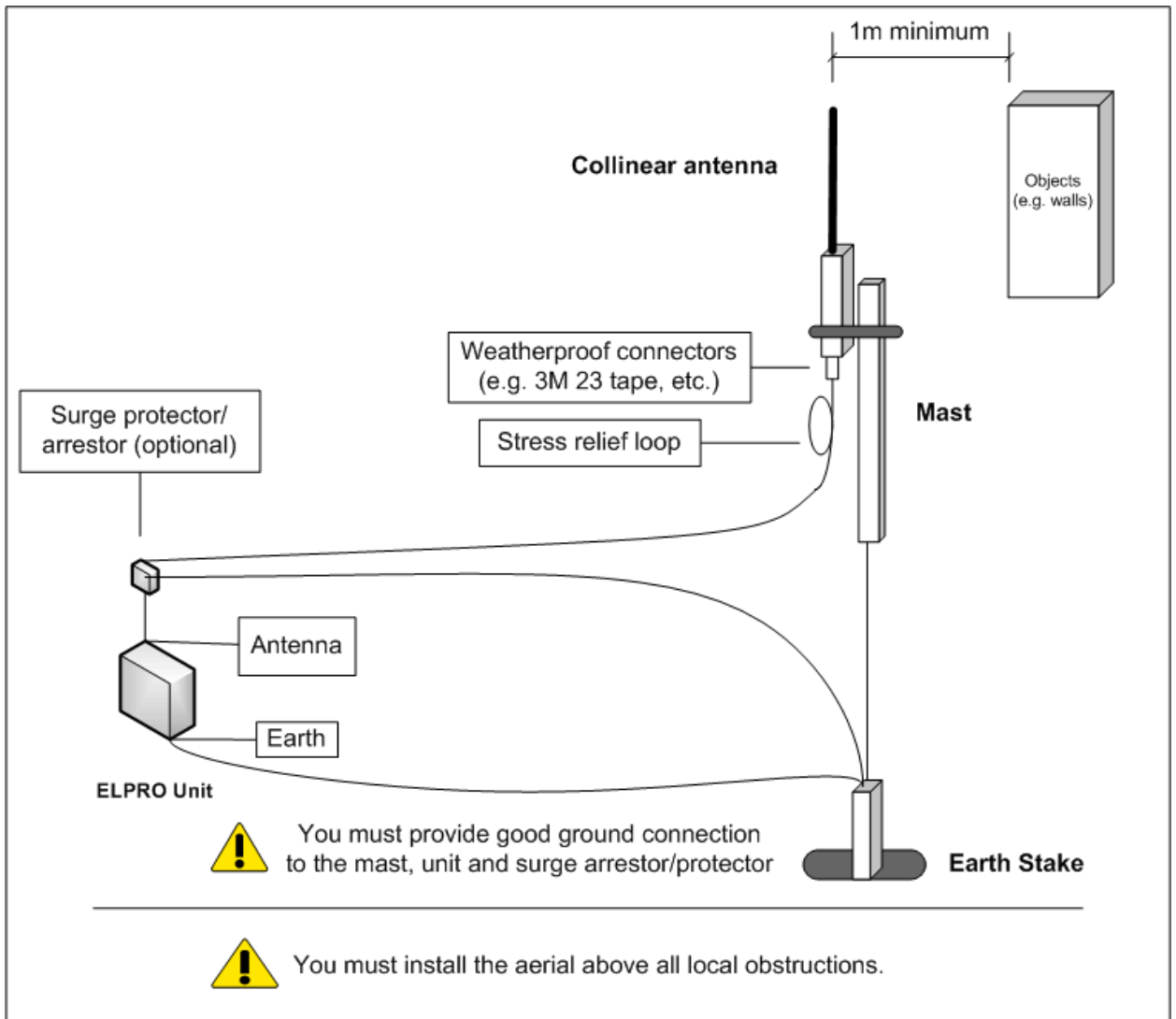



Yagi antennas

Yagi antennas are directional and have positive gain to the front of the antenna and negative gain in other directions. You can use the gain to:

- **Compensate for coaxial cable loss for transmitter unit;** and
- **Increase receive sensitivity for receiver units.**

You should install Yagi antennas with the central beam horizontal and pointed directly in the transmission direction to benefit from the antenna gain.

Note

Yagi antennas usually have a drain hole on the folded element. You should position the drain hole at the bottom when installing the antenna.

You can install Yagi antennas:

- **Vertically polarized** – with the elements in a vertical plane; or
- **Horizontally polarized** – with the elements in a horizontal plane.

The following table shows the recommended installation mode for different situations.

If your installation has ...	ELPRO recommends using ...
Two stations both using Yagi antennas	<ul style="list-style-type: none">• Horizontal polarization for the stations.
Two or more stations communicating with a common station	<ul style="list-style-type: none">• Vertical polarization for the stations; and• Dipole or collinear (i.e. non-directional) antenna for the central station.



The following diagrams shows the recommended installation for collinear and dipole antennas:

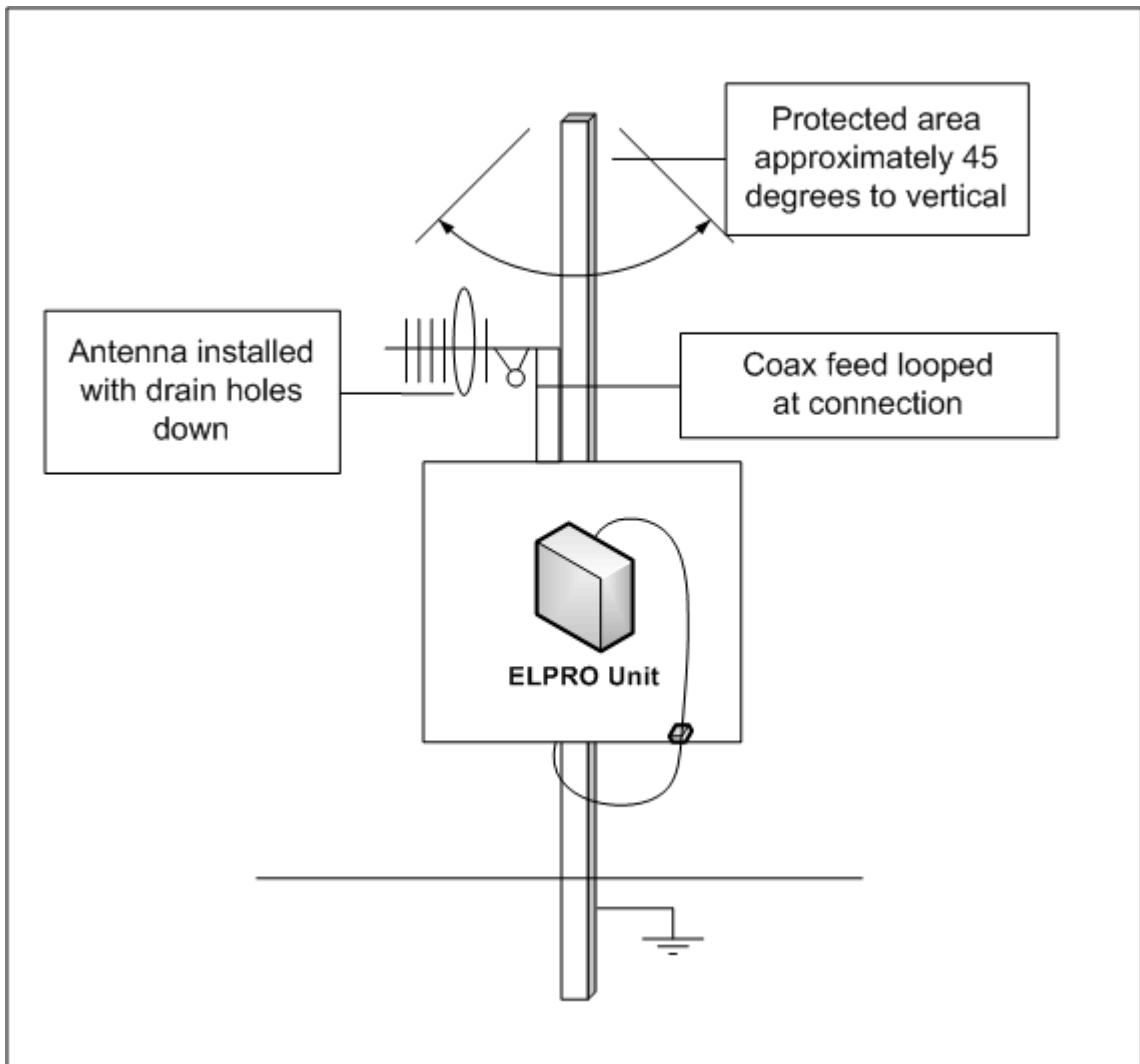



Installing the power supply

The unit works with a 9-30 VDC 0.6 Amp CSA certified Class 2 power supply. For use in Class 1 Div 2 explosive areas, the power supply must be approved for Class 1 Div 2 use.

Warning – explosion hazard

Do not disconnect while circuit is live unless area is known to be non-hazardous.

The following table shows the power supply requirements:

Power supply	905U-L-T	905U-L-R
12V	600 mA	250 mA
24V	300 mA	125 mA

The power supply can be a floating supply or negatively grounded.

The transmitter provides a 24V DC regulated supply for analog loop power. The supply is rated at 35 mA and should ONLY be used for powering analog loops.

To install the power supply:

1. Connect the positive lead to **Power Supply Input**.
2. Connect the negative lead to **Ground**.

Note

To ensure internal surge protection works correctly, you must earth each unit using the Earth terminal.

You should connect the module to the same ground/earth point as the antenna mounting to avoid differences in earth potential during voltage surges.

Do NOT connect the positive side of the supply to Earth.

3. The following diagram illustrates the connection:

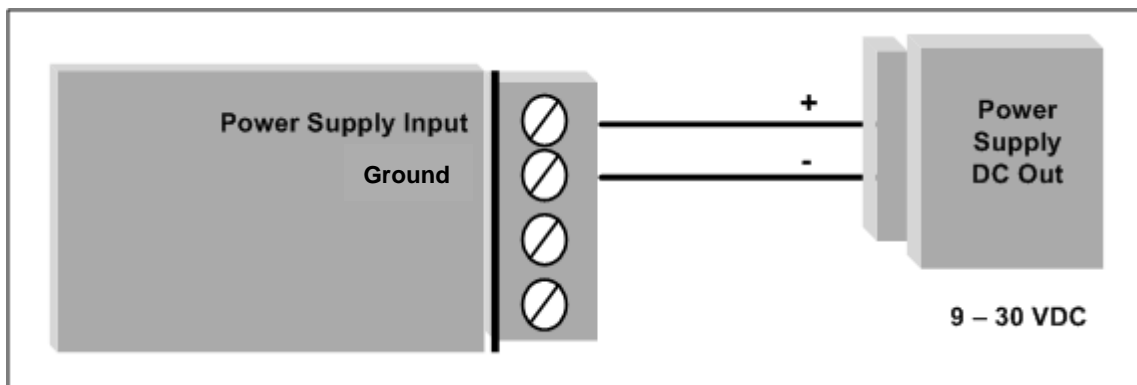



Inputs and outputs

The units have the following inputs and outputs:

Input/output	905U-L-T	905U-L-R	Description	For more information, see ...
Digital inputs	2		Suitable for Voltage free contact, NPN transistor, 0-5V signal.	Digital inputs on page 23.
Relay outputs		3	250VAC 1A / 30VDC 1A.	Relay outputs Important Information on page 24.
Status outputs	2	2	Max 30VDC, 500 mA. Indicate module status, communication failure and local setpoint status.	Status outputs on page 25.
Analog inputs	1		4-20 mA with over-range and under-range. 0-10 mA with over-range.	Analog input on page 26.
+24V Loop supply	1		Provides power for 1 external current loop (up to 35 mA).	Installing the power supply on page 21.
Analogue setpoint	1		Allows discrete setpoint to be controlled from analog input. Threshold adjustable via rotary switch.	Refer to the User Manual .
Thermocouple / millivolt input	1		Provides measurement of E, J, K, T type Thermocouple, millivolt signals and user-defined thermocouple types.	Thermocouple input on page 29
Thermocouple setpoint	1		Lets you control discrete setpoint from thermocouple with threshold adjustable via rotary switch.	Refer to the User Manual .
Pulse inputs	2		Up to 10Hz.	Pulse input on page 30.
Analog output		1	0-22 mA, suitable for loop powered, floating input or single-ended input device.	Analog output on page 31.

For more information, see the next sections.



Digital inputs

The 905U-L-T module provides two digital inputs suitable for:

- **Voltage free contacts** – e.g. mechanical switches; or
- **NPN transistor devices** – e.g. electronic proximity switches; or
- **0-5V signals** - 2V – 4V Minimum range.

Note

PNP transistor devices are not suitable.

The unit provides contact wetting current of approximately 5mA to maintain reliable operation of driving relays.

Each digital input is connected between the appropriate **Digital Input** terminal and **Ground**.

Each digital input circuit includes a LED indicator that lights when the digital input is active (i.e. when the input circuit is closed).

To activate the digital input, the switching device resistance must be less than 200 ohms.

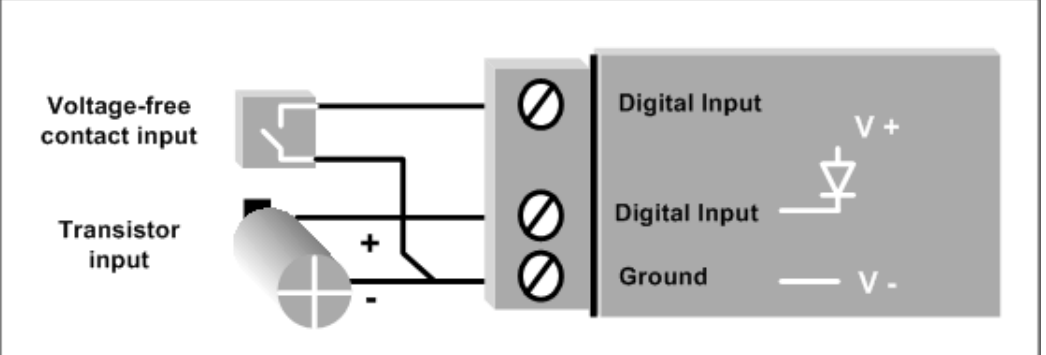
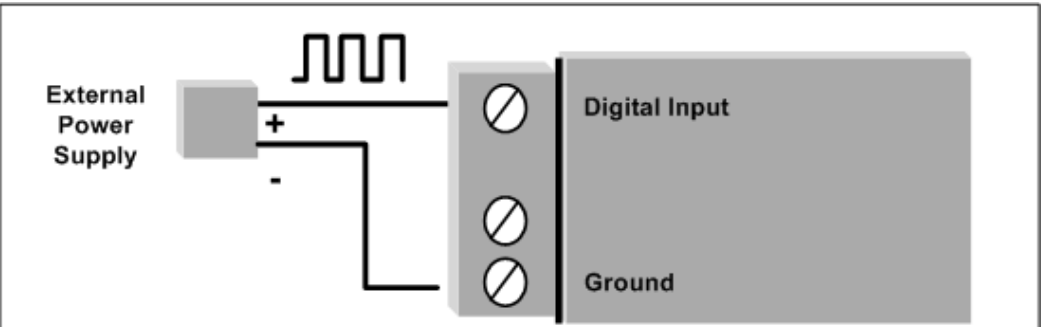
Connection method	Example
Voltage free contact	
Active 0-5v signal device	 <p data-bbox="523 1724 1428 1870">Note Use a solid state relay if the voltage range is not suitable. Voltage Range is low: 2V (max); high: 4V (min).</p>



Relay outputs

The 905U-L-R module provides three normally open voltage-free relay contacts rated at 250VAC / 30VDC 1A.

You can use these outputs to directly control low-powered equipment or power larger relays for higher-powered equipment.

For inductive loads, ELPRO recommends:

DC relays - use flyback diodes across the external circuit to prevent arcing across the relay contacts.

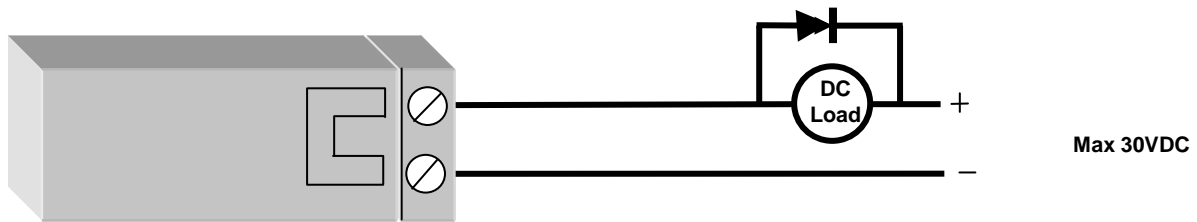

AC relays – use capacitors (e.g. 10nF 250V) to prevent arcing across the relay contacts.

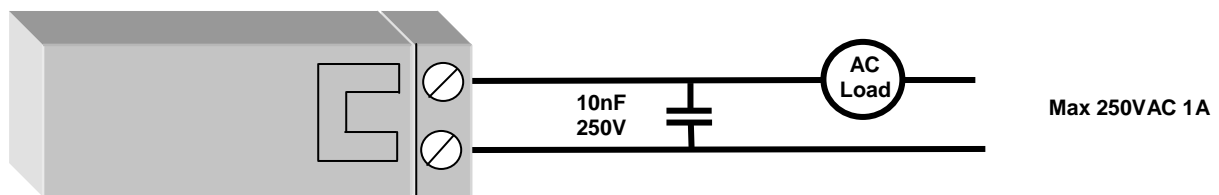

You can individually configure digital outputs to turn off if no command message is received by the output for a certain period. This feature provides an intelligent watchdog for each output, so communications failure at a transmitting site causes the output to revert to a known state.

The output circuit is connected to the appropriate pair of **Digital Output** terminals. Each digital output circuit includes a LED indicator that lights when the digital output is active. The LED flashes if the watchdog alarm is active.

IMPORTANT SAFETY INFORMATION

In order to comply with Electrical Safety Standards, when connecting SELV **AND** voltages which are greater than SELV (30VAC or 60VDC) together, then Relay Output 2 must **NOT** be used in order to provide sufficient isolation between the outputs



Status outputs

The unit contains the following status outputs:

- **System OK;**
- **Setpoint Output;** and
- **Communications Failure.**

Status outputs are FET output to common rated at 30VDC 500 mA.

Connect the output circuit to the appropriate Status **Output** terminal. Each status output circuit is associated with an LED indicator that lights lit when the digital output is active.

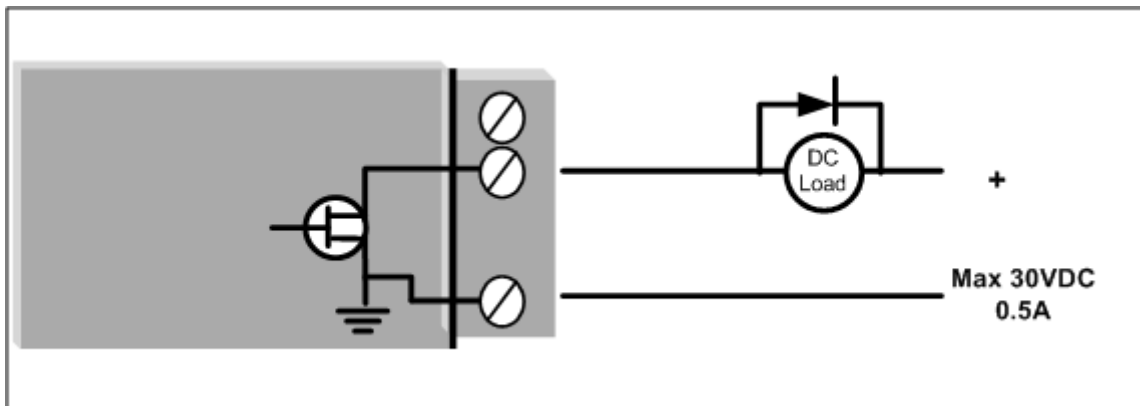

The following table details the status output behavior:

Status output	LED	LED status	Description
System OK active (both modules)	OK	Green	No fault detected
System OK inactive	OK	Red	<ul style="list-style-type: none">• Internal fault detected.• Supply voltage Low• Analog Loop supply overloaded
Setpoint Output (905U-L-T)	SP	Green	Local setpoint attached to 4-20mA analog input.
Communications Failure (905U-L-R)	CF	Red	Watchdog alarms active on digital outputs or analog outputs.



Analog input

The 905U-L-T module provides one 0 - 20 mA DC analog input for connecting to instrument transducers (e.g. level, moisture, pressure transducers, etc.).

Note

The 905U-L-T module inputs measure down to 0mA and can also be used for zero based signals (e.g. 0 - 10 mA).

The analog input has a positive and negative terminal and can be placed at any point in the current loop, providing neither input rises above the 24 volt **Analog Loop Supply** level.

Each input has a loop resistance of less than 250 ohms and zener diode protection is provided against over-voltage and reverse voltage.

Note

You may require additional protection in high voltage or noisy environments or for long wiring runs.

A 24VDC loop supply is available on the 905U-L-T module for powering the analog transducer loops. In this situation, connect the:

- ▶ **Analog loop** - between an **Analog Input (-)** terminal and **Ground**.
- ▶ **Positive terminal** – i.e. **Analog Input (+)** to the +24V **Analog Loop Supply**.

Externally powered loops may be connected by connecting the input between "Analog Input (+)" and "Analog Input (-)" Common mode voltage may be -0.5V to 27V.

ELPRO recommends using shielded cable for analog I/O loops to minimize induced noise and Radio Frequency Interference (RFI).

Note

You should only connect one end of the cable shield to Earth

To connect an analog signal from a PLC or DCS output to an analog input on the 905U-L-T, you must carefully check the internal circuit of the output as different devices use different ways to create an analog signal.

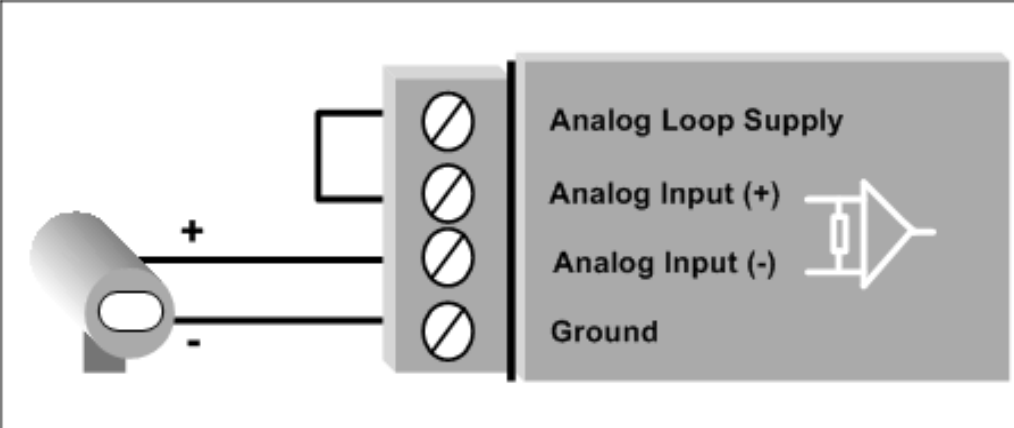
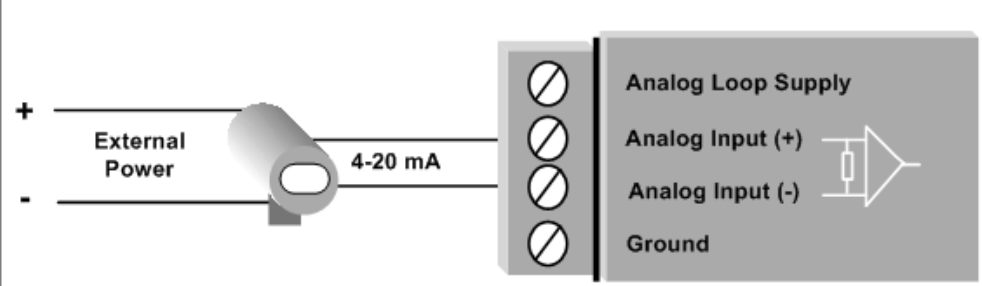
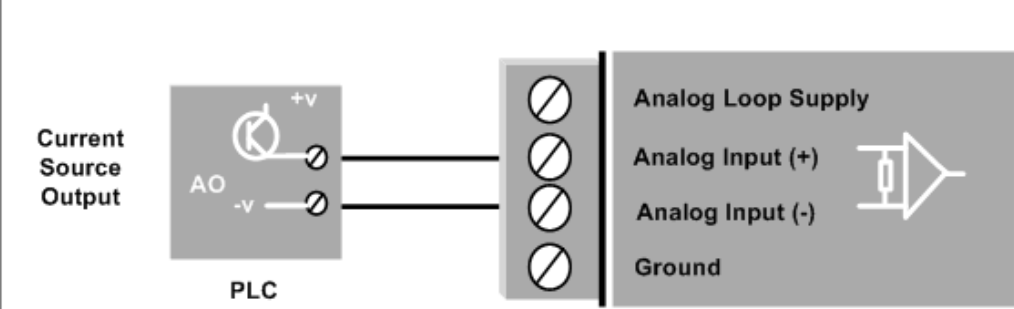

The following diagrams illustrate different connection methods:

Analog signal source	Example
2 wire transducer	 <p>Analog Loop Supply Analog Input (+) Analog Input (-) Ground</p>
4 wire transducer	 <p>External Power 4-20 mA</p> <p>Analog Loop Supply Analog Input (+) Analog Input (-) Ground</p> <p>Note Analog input must be within 27V of Ground. If your terminal voltage exceeds this, you must use a loop isolator.</p>
Current source output	 <p>Current Source Output AO +v -v PLC</p> <p>Analog Loop Supply Analog Input (+) Analog Input (-) Ground</p> <p>Note 1. Analog input must be within 27V of Ground. If your terminal voltage exceeds this, you must use a loop isolator. 2. Ground is connected to ground/earth. If you cannot ground the PLC COM, you must use a loop isolator.</p>

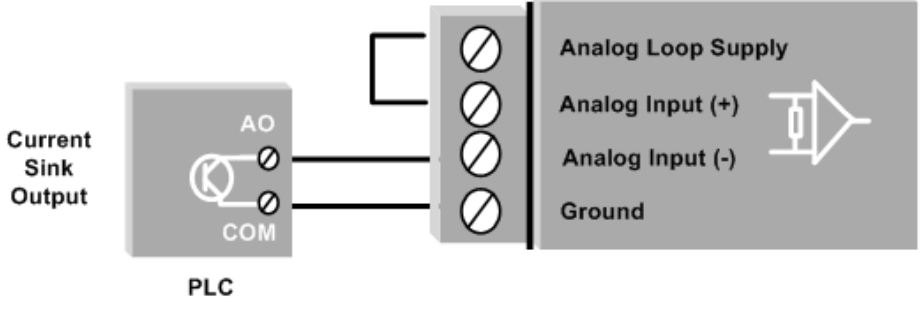

Analog signal source	Example
Current sink output	 <p>Note 1. Ground is connected internally to Earth. If you cannot ground the PLC COM, you must use a loop isolator.</p>



Thermocouple input

The 905U-L-T provides one input suitable for connection to a thermocouple or a millivolt level signal. The module provides linearization tables for J, K and T type thermocouples and also supports other types via a user linearization table.

Millivolt signals in the range -10mV to +100 mV are supported.

For more information on configuring the thermocouple input and cold-junction compensation to suit your application, refer to the **User Manual**.

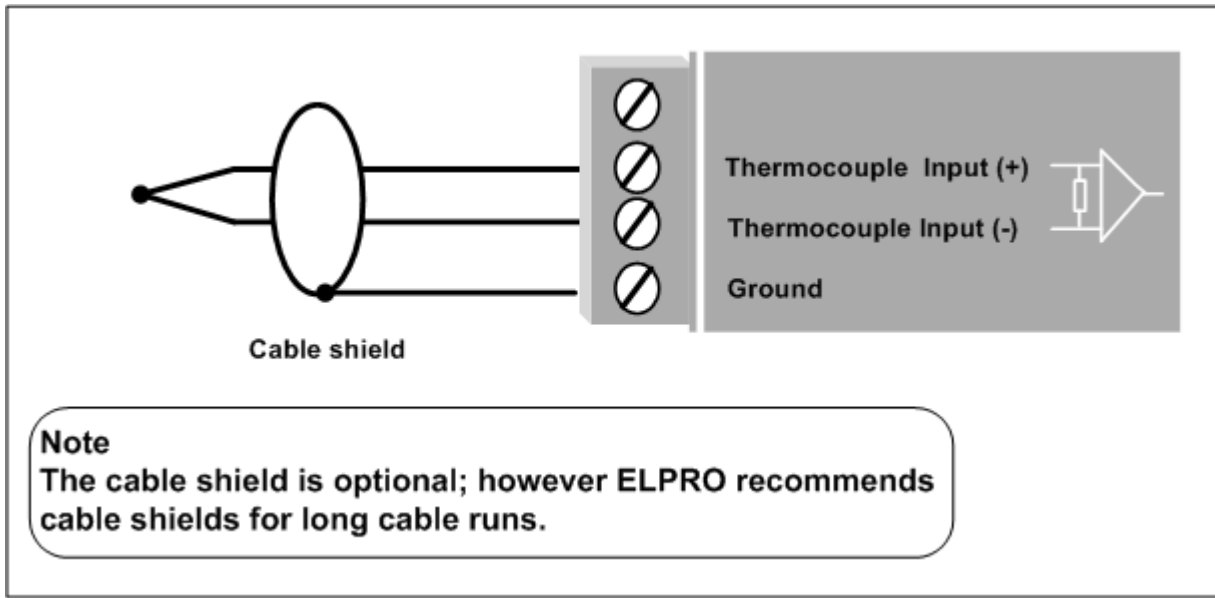



Pulse input

The 905U-L-T module lets you configure the digital inputs as pulse inputs with the following characteristics:

Characteristic	Value
Maximum rate	10 Hz
Minimum off time	20 mSec
Minimum on time	20 mSec

Using this mode, you can map the pulse count to a remote output by transmitting the pulse count to a 905U-G module register or re-generating as a Pulse Output on 905U-1 or Digital Output on a 905-3 unit.

Note

You should connect the pulse input in the same way as a digital input.

The following diagrams illustrate different connection methods:

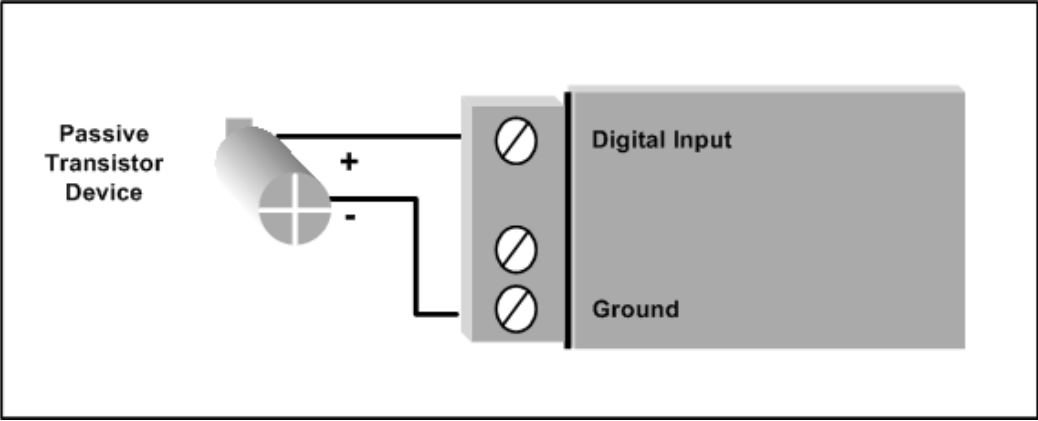
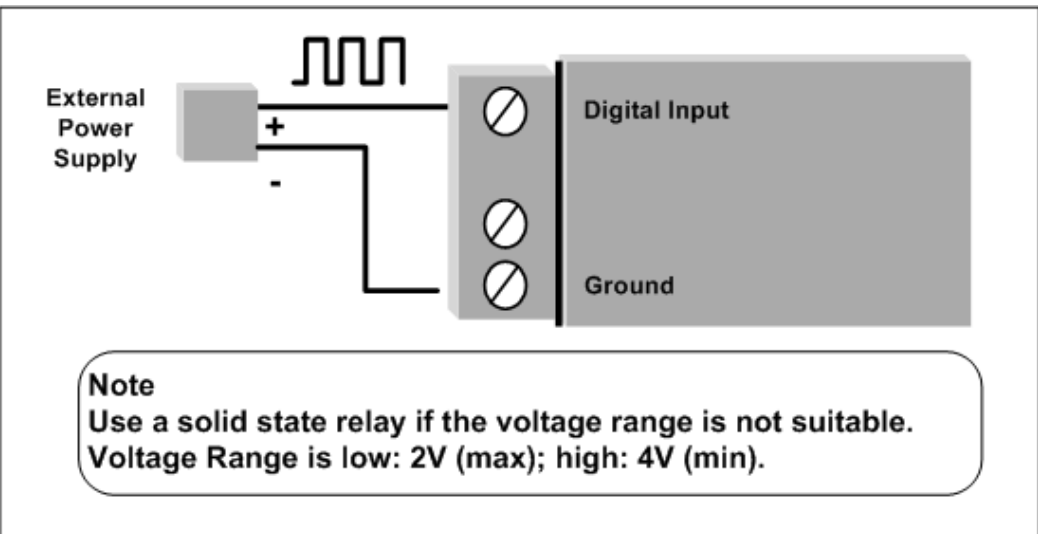
Connection method	Example
Passive transistor	
Active pulse device	



Analog output

The 905U-L-R module provides a 4 - 20 mA DC analog output for connecting to instrument indicators to display remote analog measurements. The analog output is a current source provided from an internally generated +24V loop supply.

When connecting to an external device (e.g. electronic indicator, recorder, PLC / DCS input, etc.) by connecting the output between the **Analog Output** terminal (+) and the **COM** terminal (-).

Note

Zener protection of analog outputs provides protection against short periods of over-voltage; however longer periods may result in module damage.

You can also individually configure analog outputs to turn off (i.e. 0 mA) if no command message is received to the output for a certain period.

The following diagrams illustrate different connection methods:

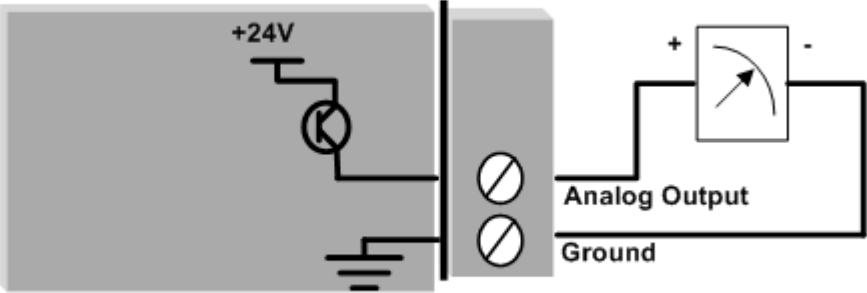
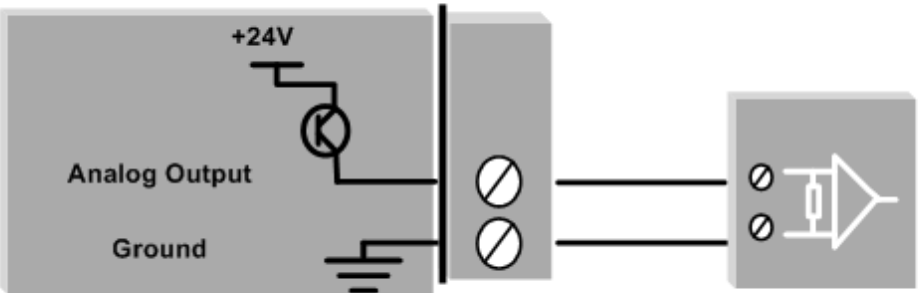
Connection method	Example
Loop powered device	
Floating input device	

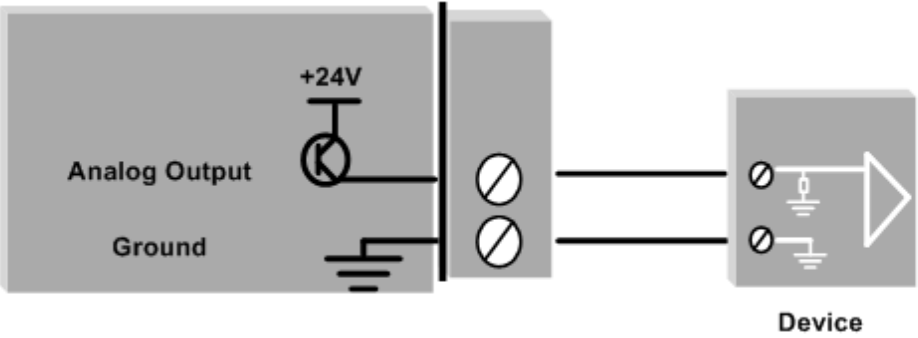

Connection method	Example
To single-ended input device	 <p>The diagram illustrates the connection of an Analog Output module to a single-ended input device. On the left, the Analog Output module is shown with a +24V supply and a Ground connection. The output terminal is connected to the input terminal of the Device, which also has a Ground connection.</p>



Installing and configuring the unit

This section describes how to install and configure your unit and contains the following sections:

Section	Description	For more information, see ...
Installing the unit	Describes how to physically install your unit.	Installing the unit on page 34.
Configuring your unit	Describes the different ways to configure your unit.	Configuring your units on page 35.
Testing your unit	Describes ELPRO's recommendations for testing your unit.	Testing your units on page 36.

For more information, see the next sections.



Installing the unit

To install the unit:

1. Connect signals to the supplied terminals.
2. Connect the radio antenna.
3. Install DIN rail to mount the module.
4. Clip the module to the DIN rail:

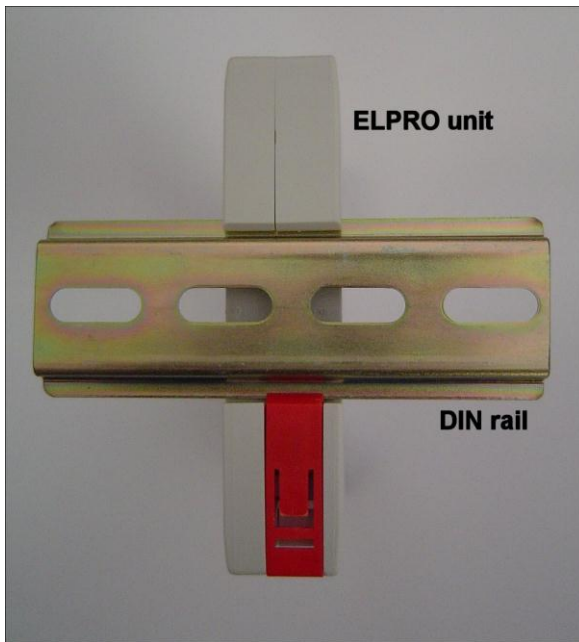

You can now configure your unit. For more information, see page 35.



Configuring your units

You can configure your network using:

- **Default factory configuration** – that lets you easily setup your network as a simple send/receive; or
- **User-defined customized configuration** – that lets you set specific information about your network and allows communication with other ELPRO 905 series devices.

For more information on setting a user-defined customised configuration, see the **User Manual**.

For more information on setting the factory default configuration, refer to the **Quick Start Guide** included with your module.

The following table details the factory default configuration:

Signals sent over radio		
905U-L-T(Transmitter)	Sends	905U-L-R (Receiver)
Digital Input 1	⇒	Digital Output 1
Digital Input 2	⇒	Digital Output 2
Analog Setpoint	⇒	Digital Output 3
Analog input (4-20 mA)	⇒	Analog output

Other signals	
905U-L-T(Transmitter)	905U-L-R (Receiver)
Thermocouple Input (Not used)	Communication Failure (Comes on if no messages from 905U-LT)
Setpoint Output (Local indication)	
System OK (On if system OK)	System OK (On if system OK)



Testing your units

We recommend you bench test the complete system before installing a new system.

Configuration problems are easier to identify and fix when the units are next to each other.

The following table describes common problems and recommended solutions:

If your installation has ...	You should check ...	ELPRO recommends ...
Poor radio channel communications <ul style="list-style-type: none"> TX LED flashes but no RX LED Output LEDs flash quickly 	<ul style="list-style-type: none"> The antenna installation. For radio interference on the same channel. The radio path is adequate. 	<ul style="list-style-type: none"> Higher performance antennas if the path is too long. Higher mounting points to overcome obstructions. Using an intermediate unit as a repeater.
Red OK LED	<ul style="list-style-type: none"> Power Supply voltage 	<ul style="list-style-type: none"> Supply should be between 9 and 30VDC.
	<ul style="list-style-type: none"> Analog loop supply current 	<ul style="list-style-type: none"> The analog loop supply is rated for 35 mA max.
	<ul style="list-style-type: none"> Module configuration 	<ul style="list-style-type: none"> Your module configuration may be invalid. Re-load or restore factory default configuration.
TX LED flashes but no RX LED (bench testing)	<ul style="list-style-type: none"> Ensure the 905U-L-R is set to the same country and frequency band as the 905U-L-T 	<ul style="list-style-type: none"> Register the receiver with the transmitter. (Refer to the Quick Start Guide)
RX LED Flashes but no outputs change	<ul style="list-style-type: none"> For a user-defined customized configuration, - check the configuration. 	<ul style="list-style-type: none"> Check the configuration and re-program the modules.
	<ul style="list-style-type: none"> For default configuration, check the receiver is registered with the transmitter. 	<ul style="list-style-type: none"> Repeat the procedure to register the receiver with the transmitter.

For support for other testing issues, please contact ELPRO.



Unit specifications

This section details the specifications for each unit.

Transmitter unit

Input/output	Number	Additional information
Digital inputs	2	Dry-contact digital inputs slow-pulsed at 10Hz. All inputs are suitable for voltage free contacts (e.g. mechanical switches) or NPN transistor devices (e.g. electronic proximity switches). NOTE: PNP transistor device inputs are NOT suitable.
Status outputs	2	Separate System OK and Setpoint Status
Analog inputs	1	0-20mA differential input; 16-bit resolution, 0.1% accuracy, 10 ohm input impedance.
Thermocouple inputs	1	J, K or T type thermocouple with on-board cold-junction compensation. Cold junction compensation accuracy $\pm 1^{\circ}$ over ambient temp range: -40° to $+70^{\circ}$ C.
Power supply	1	9-30 VDC 0.6 Amp CSA certified Class 2 power supply. For use in Class 1 Div 2 explosive areas, the power supply must be approved for Class 1 Div 2 use. WARNING: Explosion hazard - do not disconnect while circuit is live unless area is known to be non-hazardous.
Transmitter	1	1-Watt Frequency Hopping Spread Spectrum (FHSS) Transmitter.
Frequency	902-928 MHz	Actual frequency range depends on country.

Receiver unit

Input/output	Number	Additional information
Digital outputs	3	Voltage-free contacts rated at 250 VAC, 1A, 30VDC 1A 2 for digital inputs and 1 for setpoint.
Status outputs	2	Separate System OK and communication failure output.
Analog output	1	16-bit resolution, 0.1% accuracy, single-ended source output.
Power supply	1	9-30 VDC 0.25 Amp CSA certified Class 2 power supply. For use in Class 1 Div 2 explosive areas, the power supply must be approved for Class 1 Div 2 use. WARNING: Explosion hazard - do not disconnect while circuit is live unless area is known to be non-hazardous.
Radio receiver	1	High sensitivity FHSS UHF radio receiver.
Frequency	902-928 MHz	Actual frequency range depends on country.
Sensitivity	-110 dBm	At BER 8%.



Ancillary hardware reference information

This section contains reference information about additional hardware components you may need for your unit.

RS232 serial cable

You can connect the unit to a PC using an RS-232 serial cable to:

- **Transfer configuration information;**
- **Perform factory and field-testing.**

The serial port is an 8 pin RJ-45 plug that communicates using standard RS-232 signals:

Signal information	Value
Baud rate	9600
Bits	8 bits with 1 stop bit
Parity	No parity

ELPRO can supply a configuration cable.

Note

The following pin-out information is for reference only.

RJ-45	Required	Signal name	Normal colour	DB9
1		Ring Indicator	Green / White	9
2		Data Carrier Detect	Green	1
3	Y	Data Terminal Ready	Orange / White	4
4	Y	Signal Common	Blue	5
5	Y	Receive Data (from Modem)	Blue / White	2
6	Y	Transmit Data (to Modem)	Orange	3
7		Clear to Send	Brown / White	8
8		Request to Send	Brown	7

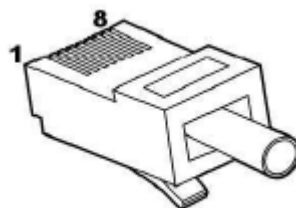



Index

2 wire transducer	28	lightening rod	17
4 wire transducer	28	lightening strike.....	17
AC relays.....	25	line of sight	16
active pulse device	<i>See</i>	linearization tables.....	30
active signal device	24	loop powered device.....	32
analog input.....	27	maximum transmission distance.....	16
analog output.....	32	mechanical switches.....	24
antennas.....	18	millivolt signal	30
compatible cables	14	net gain.....	15
dipole	18	obstructions	16
installing	16	intermediate	16
polarization.....	20	over-voltage.....	27
supported antennas	14	passive transistor.....	31
arcing.....	25	pin-out.....	39
bench testing	37	PLC	27
cable		polarization	20
loss.....	15	polarized.....	20
cables		power supply	22
for antennas	14	installing	22
supported cables.....	14	problems.....	37
CFD890EL.....	14	pulse input	31
coaxial surge diverter	17	PVC tape	17
configuration		Radio Frequency Interference	27
default factory.....	36	receiver	
user-defined customized	36	components.....	12
configuring.....	36	front panel	13
connections		LEDs	13
taping	17	terminal connections	12
current sink output.....	29	relay outputs.....	25
current source output.....	28	reliable path	16
DC relays.....	25	repeater	16
DCS	27	reverse voltage	27
digital inputs.....	24	RFI.....	27
DIN rail	35	RJ-45.....	39
dipole antennas	18	rotary switch	10
electronic proximity switches	24	changing position	10
explosive areas.....	22	setpoint levels	10
floating input device.....	32	RS-232	39
flyback diodes.....	25	serial cable	39
gain		setpoint	
net gain	15	thermocouple	23
horizontal polarization.....	20	setpoint levels.....	10
installing	35	SG900-6	14
instrument transducers	27	SG900EL.....	14
interference.....	16	shielding	17
internal surge protection	22	signals	36
LEDs		single-ended input device.....	33
receiver	13	SMA connector.....	17
transmitter	11	solutions	37



specifications	38	transmitter	
status outputs	26	components.....	9
surge diverter.....	17	front panel	10
surge protection.....	17	terminal connections	9
surge suppression	17	UV-stabilized tape	17
switches		vertical polarization	20
electronic proximity	24	voltage free contact	24
switches		vulcanising tape.....	17
mechanical.....	24	watchdog alarm	25
taping connections.....	17	WH900.....	14
testing.....	37	YU16/900.....	14
thermocouple.....	30	YU6/900.....	14
thermocouple setpoint	23	zener diode protection	27
transducers.....	27	zero based signals.....	27